

Article number: 059041360

Description: Hepco cap seal CW 360

Measures

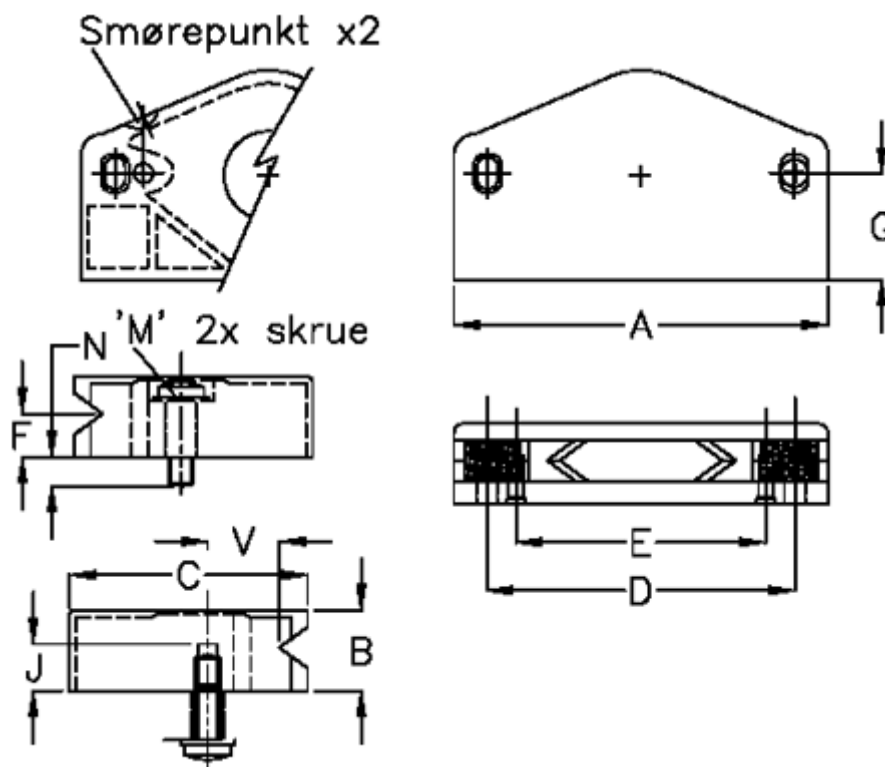

A = 72	M	= M4x16
B = 15.5	N	= 5.5
C = 40.8	V	= 13.8
D = 59	Weight kg/1000 = 0.020	
E = 48.0		
F = 8.3		
G = 20.5		
J = 9.0		